

Custom Gearing Solutions

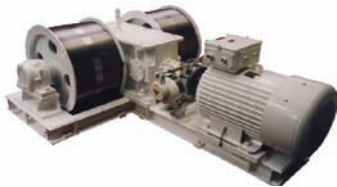
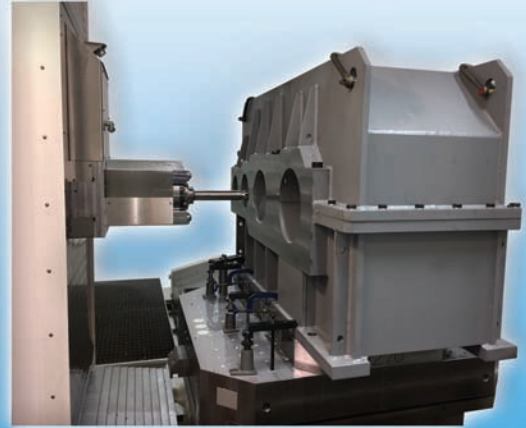
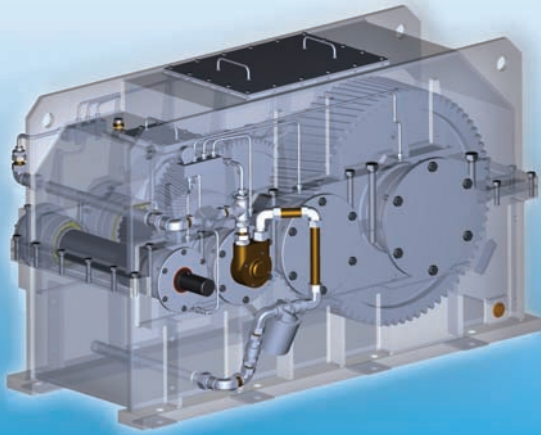

- Package Drives
- Custom Design
- Critical Applications
- Replacement Units
- Custom Gears

RENOLD
Quality Gearing Solutions Partner

Custom Gearing Solutions

Renold is a global engineering group with over 130 years of experience in the design and manufacture of high-quality power transmission products and application-specific solutions.

Application knowledge and engineering expertise, together with global manufacturing and service, ensures that Renold is your ideal partner – whatever your industry need. It is this unique industry experience gained in demanding global environments that makes the vital difference.

Our skilled engineers work closely with customers to provide a wide range of solutions for critical, real-life applications. Solutions that are proven to stand the test of time – that is why we believe in the principle: 'Engineering for Life'.

Package Drives

Incorporating more than just a gearbox.
Complete power transmission solutions.

Custom Design

Gearboxes to meet your application.
Designed and manufactured to customers' specific dimensions.

Critical Applications

Gearboxes where design verification is critical.
Custom, or in certain instances, standard design gearboxes, engineered to meet exacting life requirements or operating conditions.

Replacement Units

Gearboxes to replace obsolete units.
Renold are able to replicate the external dimensions of an obsolete gear unit, to enable the gear unit to be fitted in the existing position with no modification.

Custom Gears

Precision and commercial worm gear sets, designed and manufactured to customer requirements or reverse engineered from samples. Precision helical and spur gears manufactured to customers' drawings.



Package Drives

Complete power transmission solutions comprising the integration of the latest motors, brakes, electronic controls, couplings, fabricated mounting plates, cooling systems and enhanced lubrication.

All components matched and optimised for the application ensuring a single source economic solution.

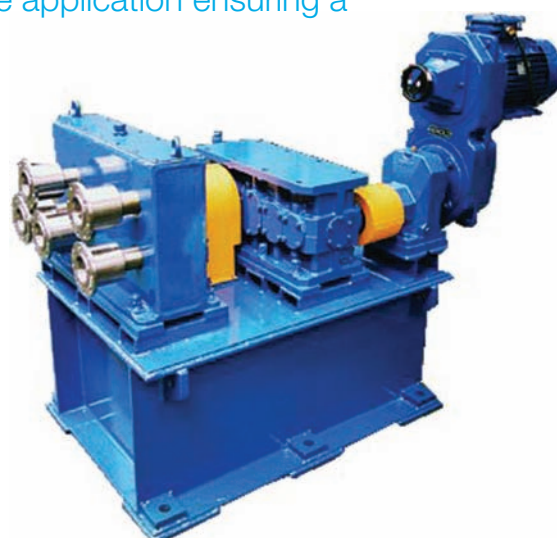
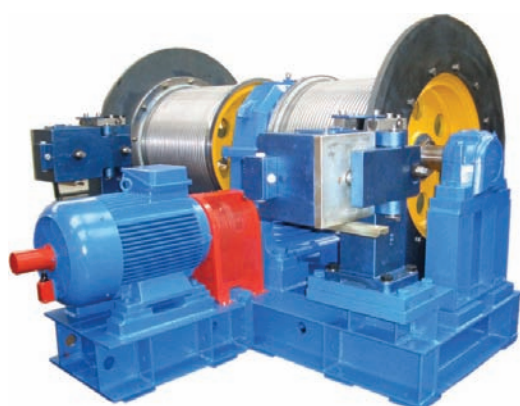

→ Applications

- Hoist drive – Mechanical and electronic package drive used to transport freight at the world's busiest airport
- Steel mill – Variable speed mill drive used to produce worldwide currency
- Escalator drive – Deep underground escalator drive in the world's oldest underground system
- Steel mill – Multiple Bogie drives used to transport a molten steel Ladle car
- Lift – Twin-braked life boat lift

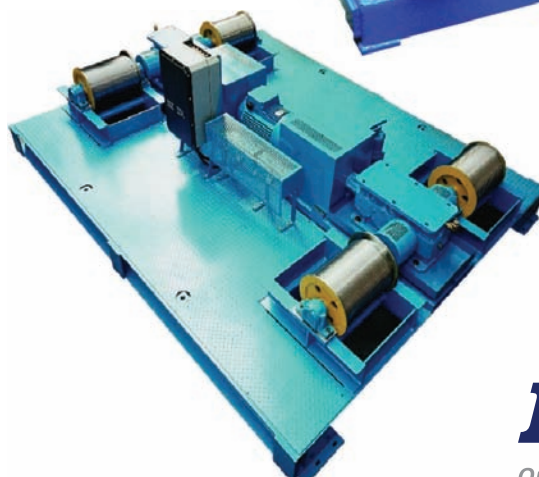
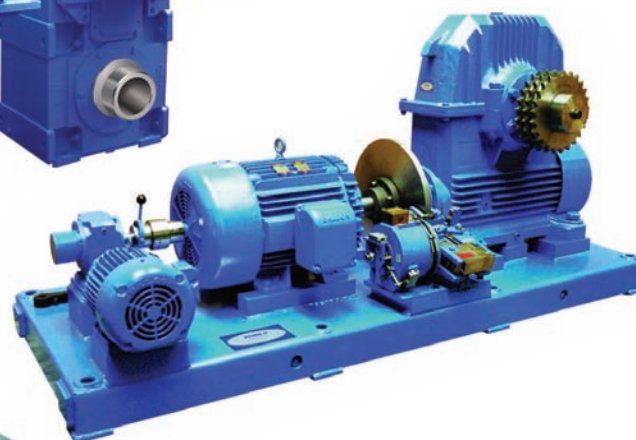
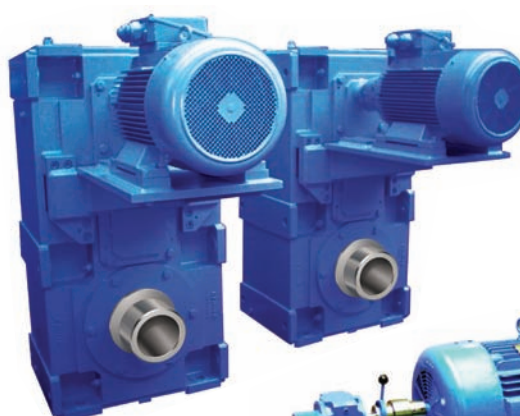

RENOLD
Quality Gearing Solutions Partner

Custom Design

Gearboxes designed and manufactured to customer specific dimensions, project managed from concept to supply.

Custom design ensuring a fully integrated solution, whilst the gearing is designed to deliver your duty and matched to the latest bearings and lubrication systems.

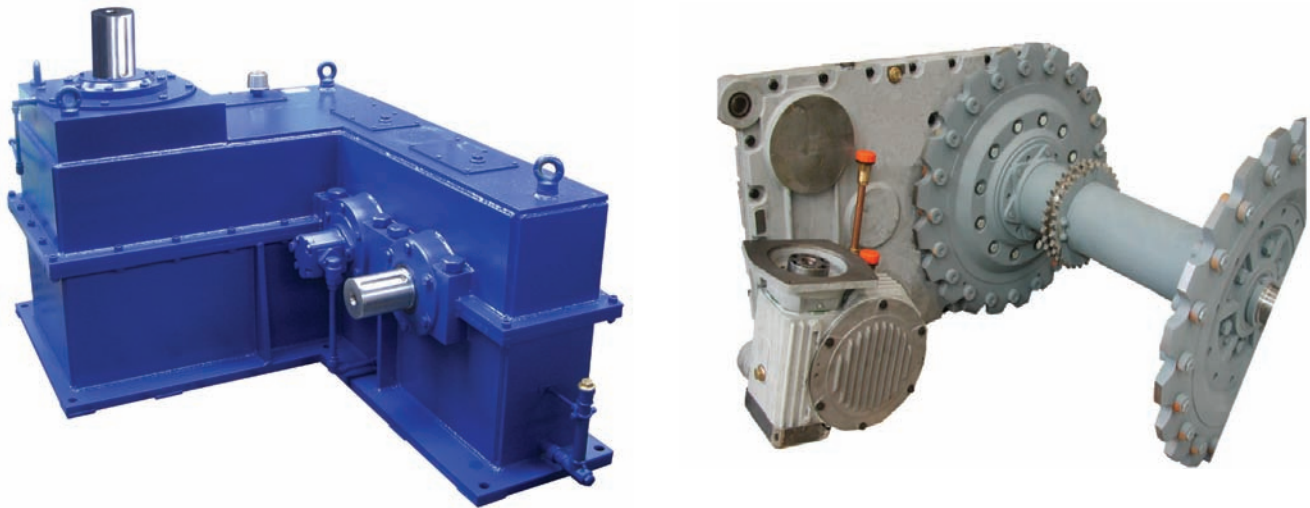

→ Applications

- Steel Mill – Pair of worm gear units forming part of a screw down mechanism in a steel mill
- Escalator drive – In truss mounted escalator drive in an above ground escalator
- Power Generation – Ocean tidal turbine used to generate renewable energy
- Power Generation – Coal-fired power station air pre heater fan drive
- Steel Mill – Centrifugal caster used to manufacture phosphor bronze blanks

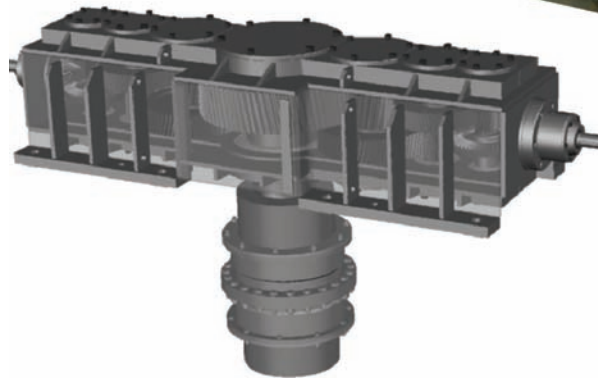

Critical Applications

Custom, or in certain instances, standard design gearboxes engineered to meet exacting life requirements or operating conditions. They require full material traceability with high shock or low noise requirements and are backed by the highest specification quality system requirements such as those demanded in the Nuclear, Marine and Defence industries.

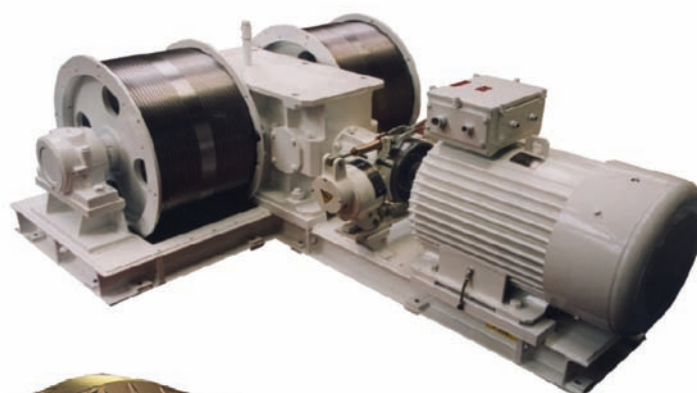

→ Applications

- Defence – Radar drive using high-specification reduction worm gear unit
- Hoist drive – Ship-mounted lift drive designed to be shock resistant
- Chemicals – Easy wash down stainless steel mixer drive
- Conveyors – Border security X-ray machine conveyor drive
- People movement – Mass transit train drive assembly

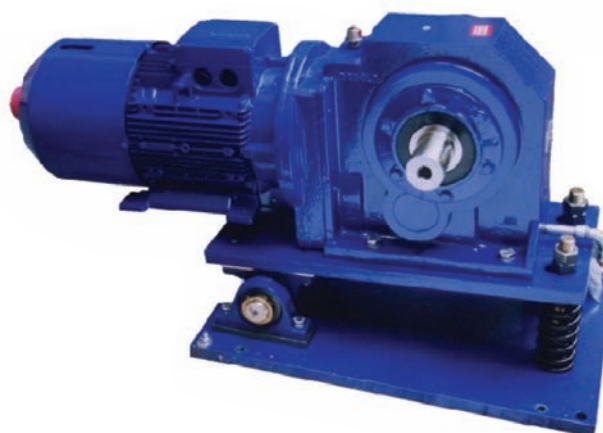
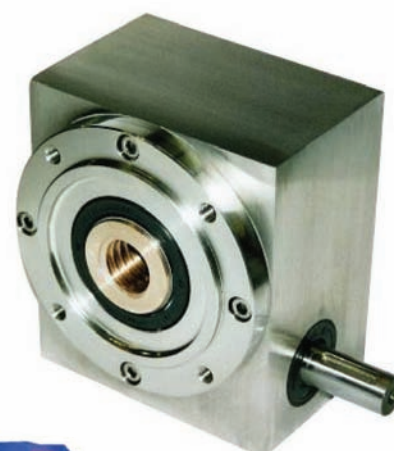

Replacement Units

Using Renold's extensive design capability we are able to replicate the external dimensions of an obsolete gear unit to enable the gear unit to be fitted in its existing position with no modification.

This solution ensures there are no retro fitting costs and minimum down time, whilst designing out inherent problems and therefore improving gearbox life.

Internally the gearbox can be, in many cases, upgraded making improvements to the gearing design or manufacturing processes. The upgrade can also be completed with commercially available, higher capacity modern bearings.



→ Applications

- Water Treatment – Re-designed drive used on an Archimedes screw which transports flood water
- Plastics – Multiple input plastics extruder made to original dimensions
- Steel – Blast furnace main door drives with couplings replacing an obsolete product
- Quarrying – Aggregate conveyor, using a modified standard casting to fit current dimensions
- Leisure – Replacement amusement bevel helical gear unit upgraded in steel housing



Custom Gears

Renold manufactures commercial and precision worm, helical and spur gears.

In the production of worm gearing, the unique Renold Holroyd gear form is widely respected for its performance and reliability in a wide range of drives. Special profiles and gear shapes can also be produced based upon the customer's requirements.

High-quality, high-specification helical and spur gears are manufactured using leading-edge technology. A dedicated gear manufacturing machine shop provides the facilities necessary to manufacture either batch or single components for the precision, high-technology engineering sectors.

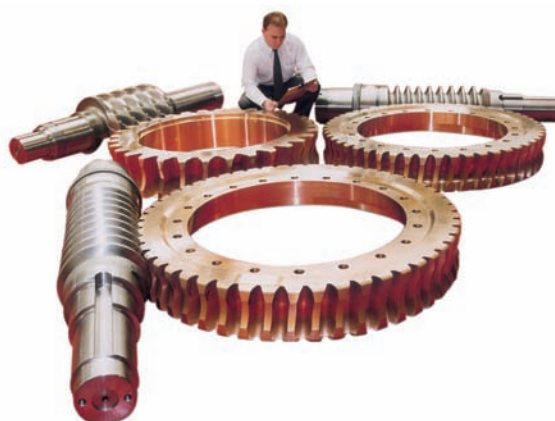

→ Applications

- Commercial Worm Gears –
 - Pulveriser Mills
 - Screw Downs
 - Replacement Gearbox Drives
 - People Movement
 - Cranes
 - Pumps
- Precision Worm Gears –
 - Machine Tools
 - Rotary Tables
 - Indexing Tables
 - Pharmaceutical Presses
 - Packaging
 - Solar Power
- Helical and Spur Gears –
 - Aerospace
 - High-performance Vehicles
 - Medical
 - Precision Industries



RENOLD

A global power transmission group serving global markets through an international network.

For your local Renold sales and service location visit www.renold.com

Superior Technology. Global Expertise.

www.renold.com



REN133/BROCGS/05.18/E
A Business of Renold Power Transmission Ltd.

RENOLD
Quality Gearing Solutions Partner